

X

M

X

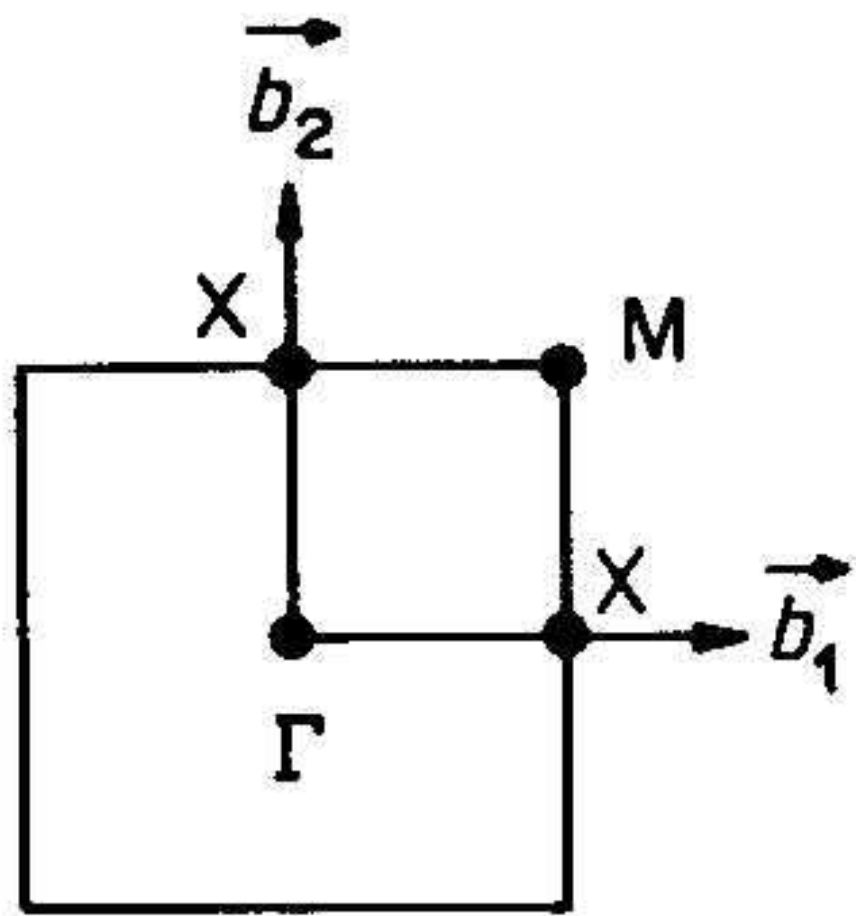

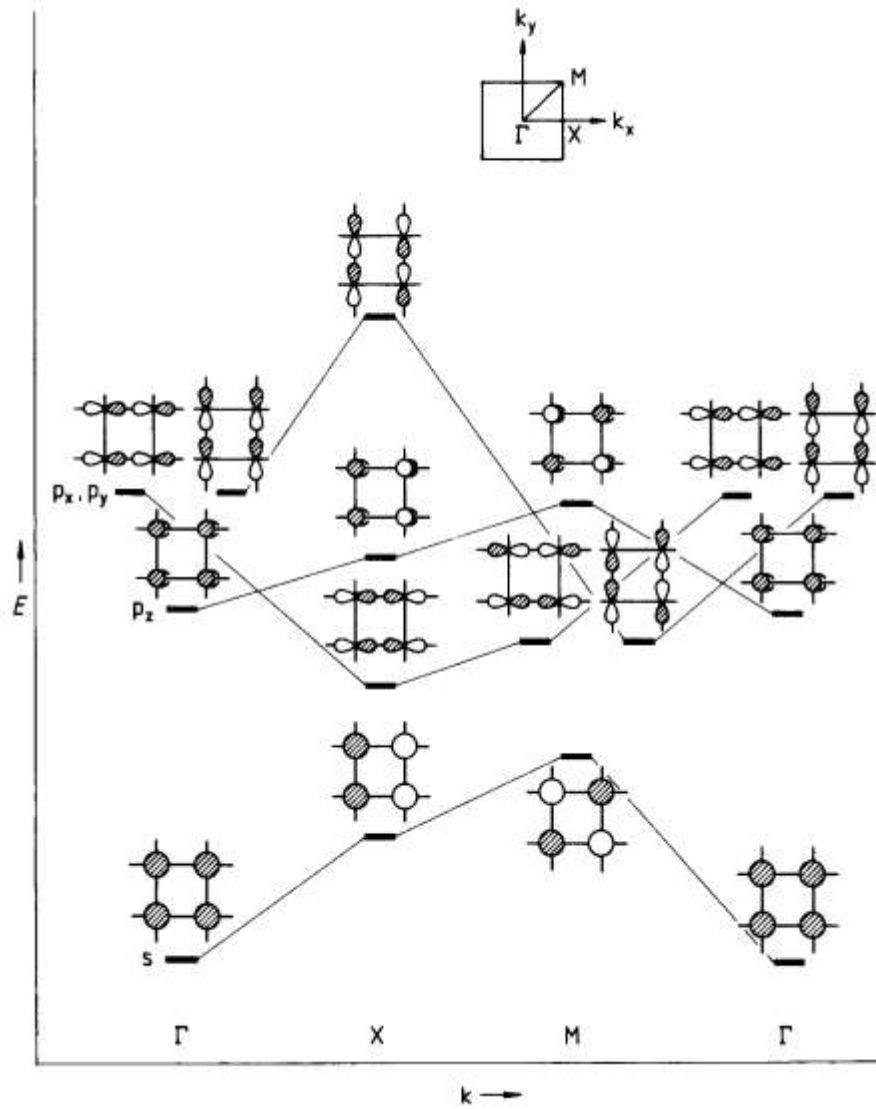

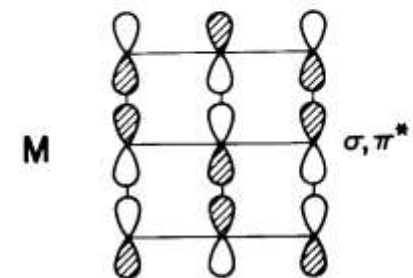
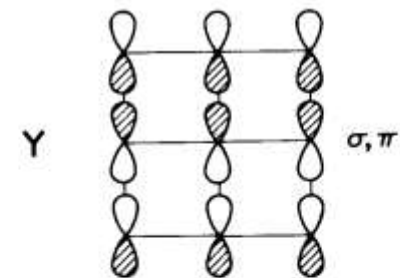
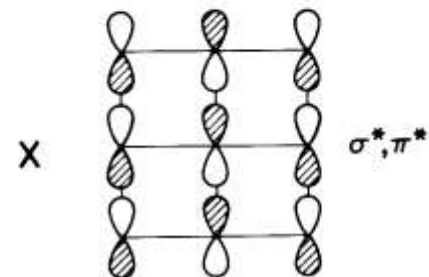
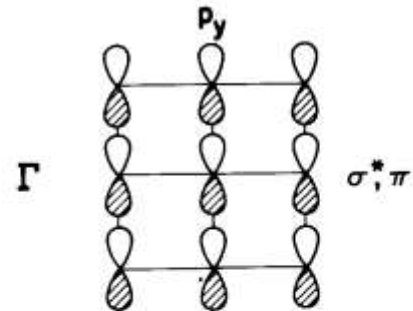
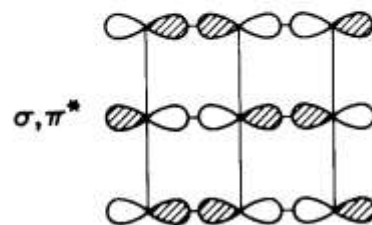
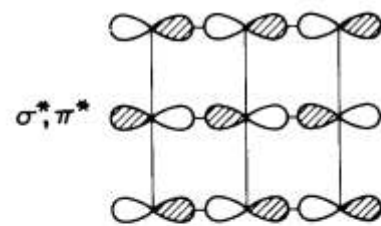
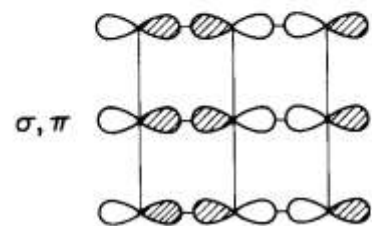
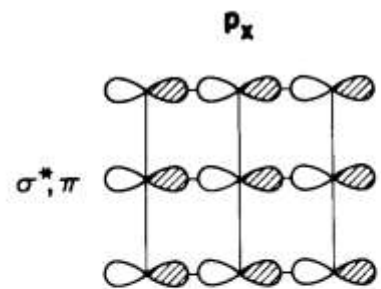

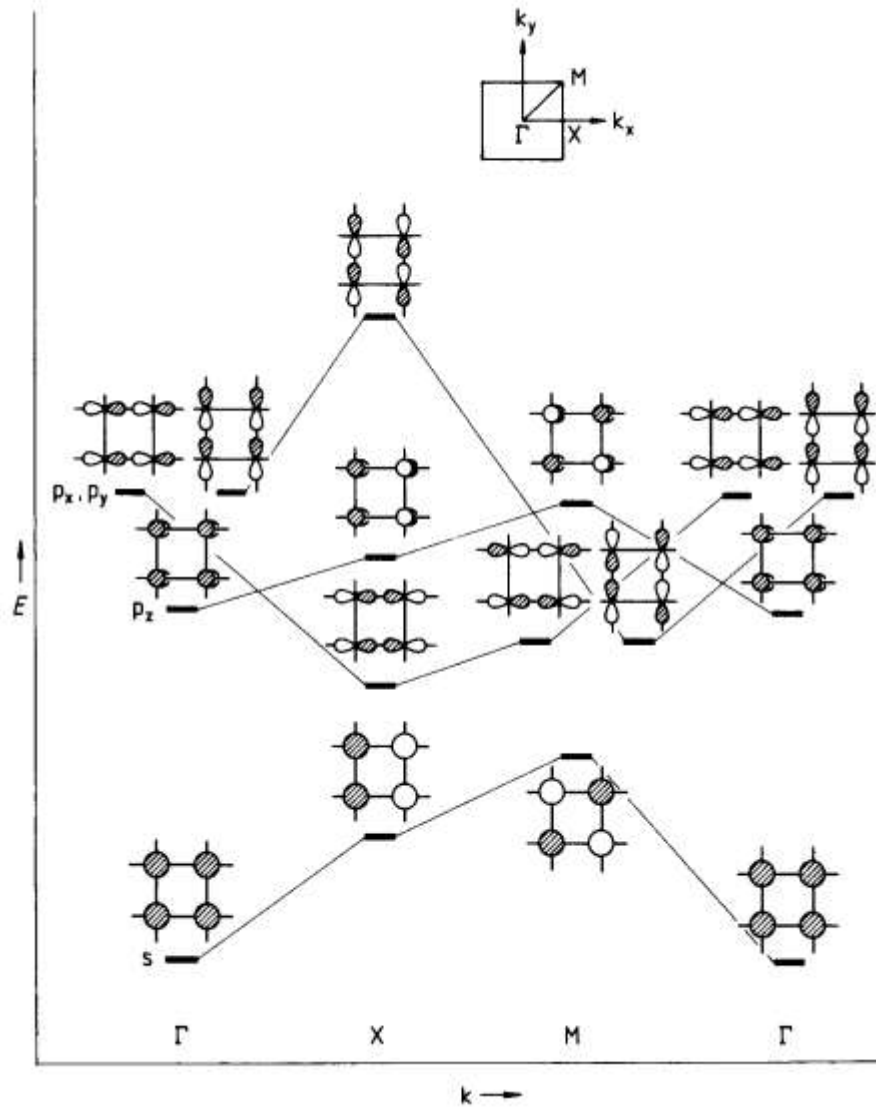

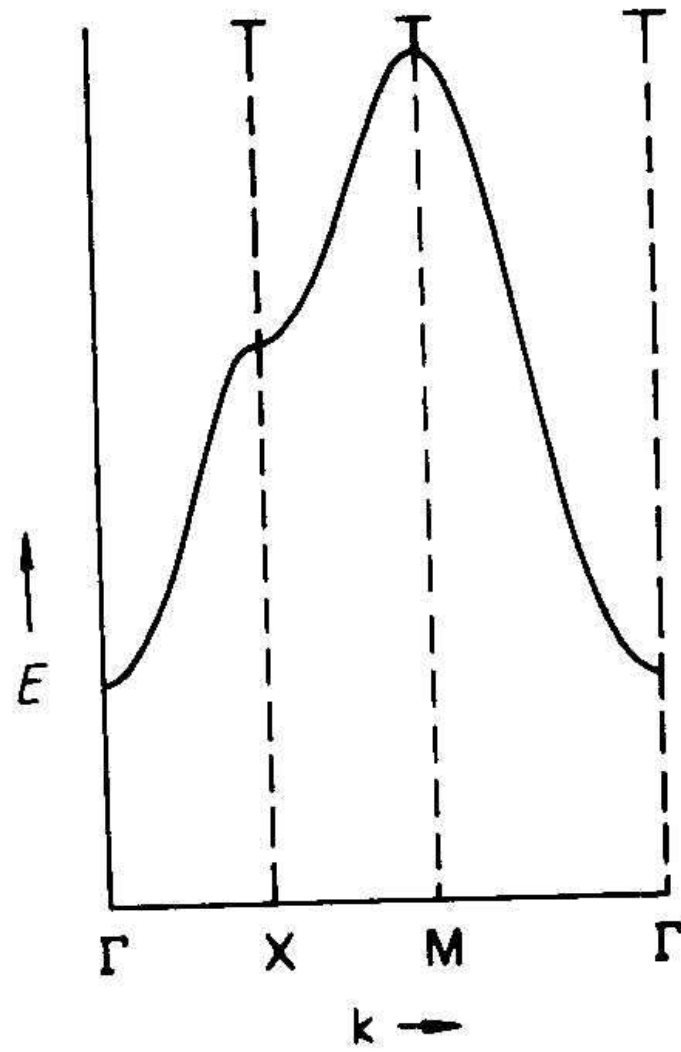

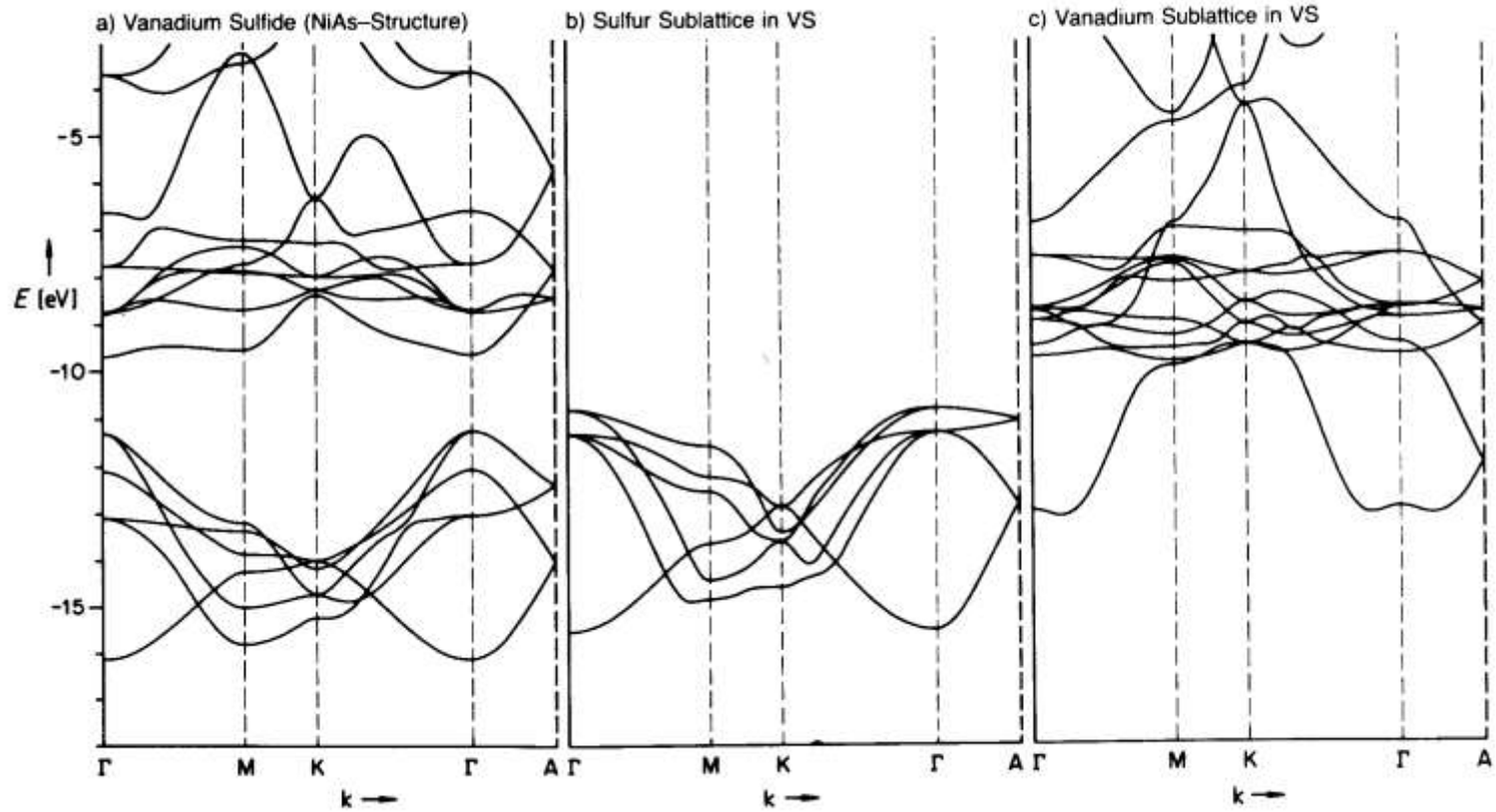

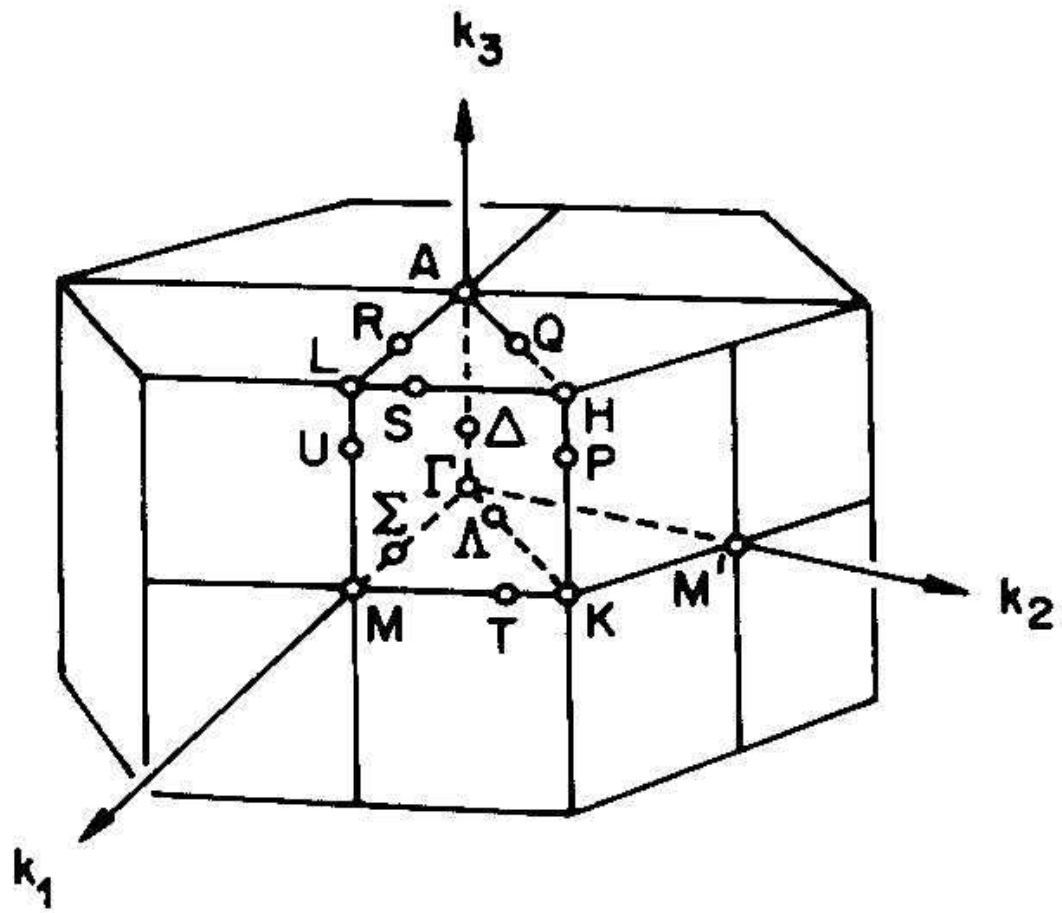

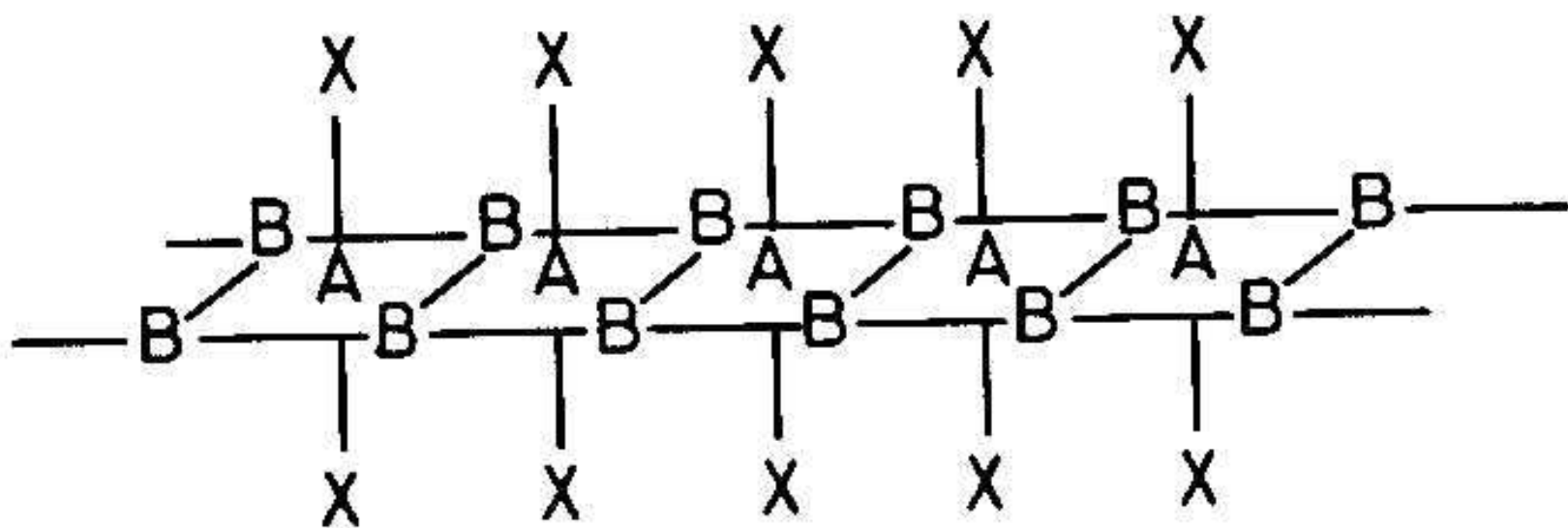

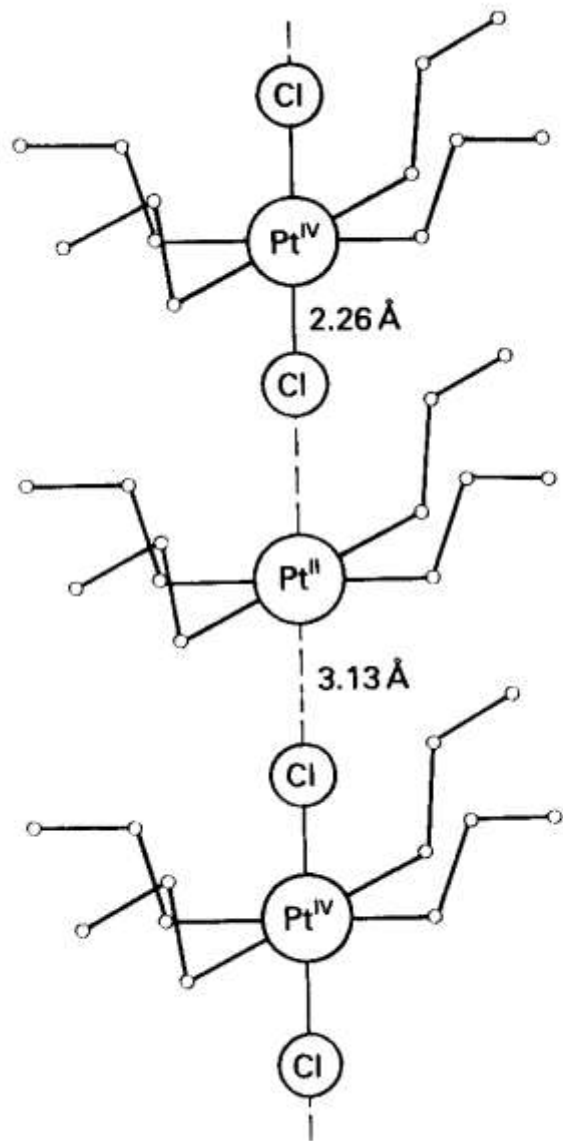

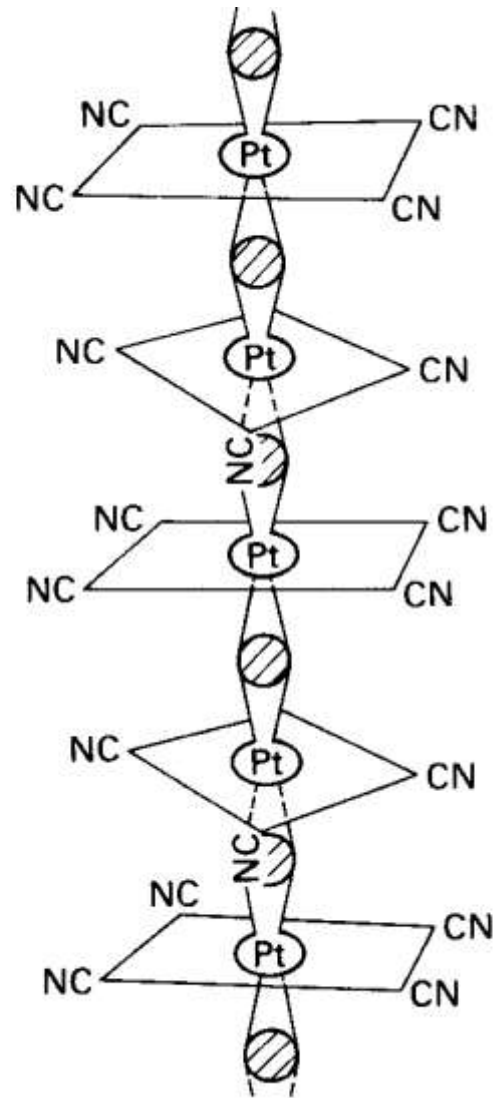

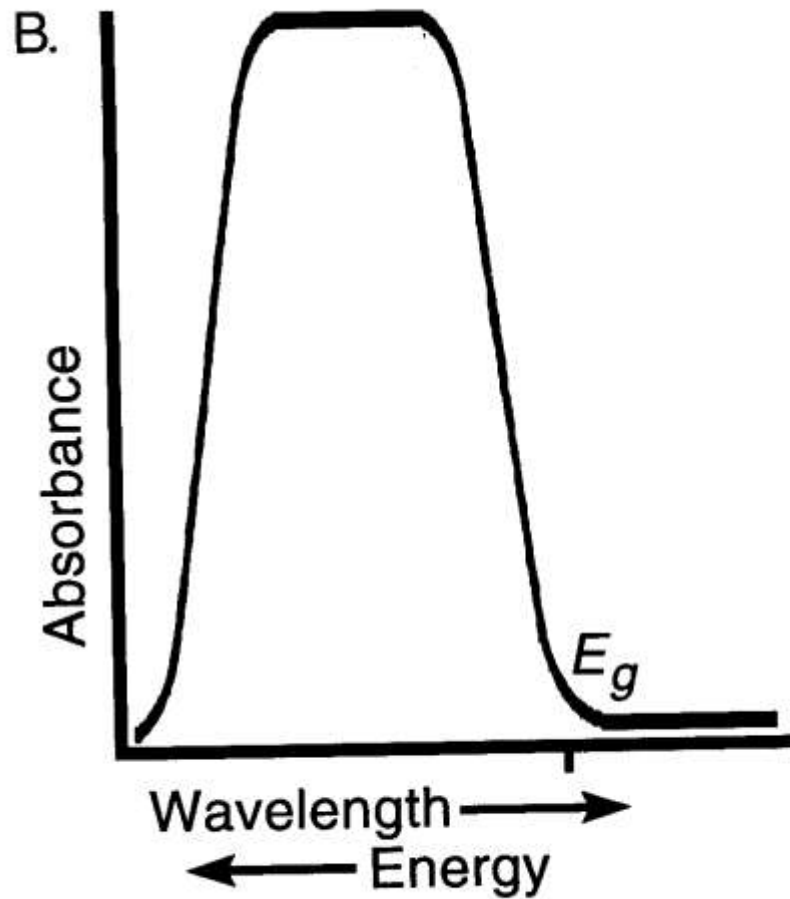
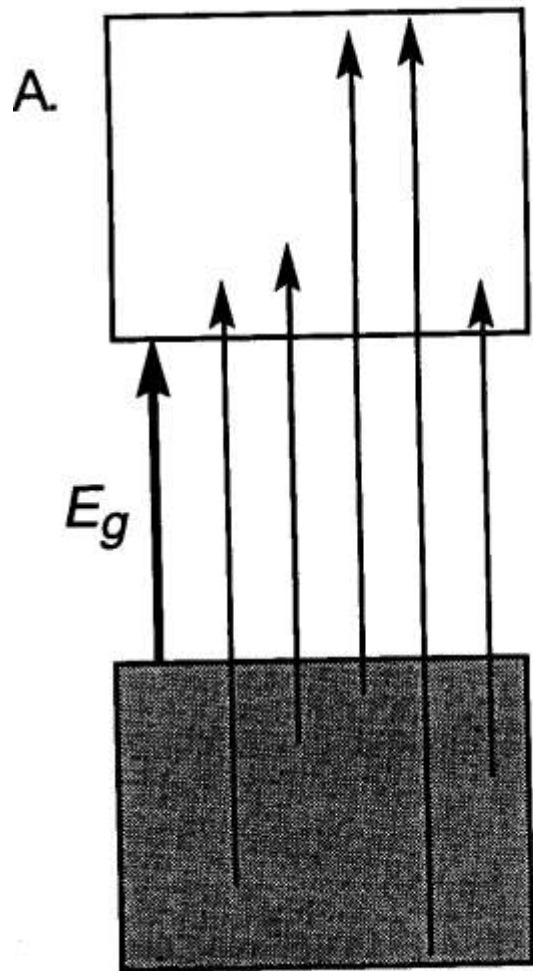

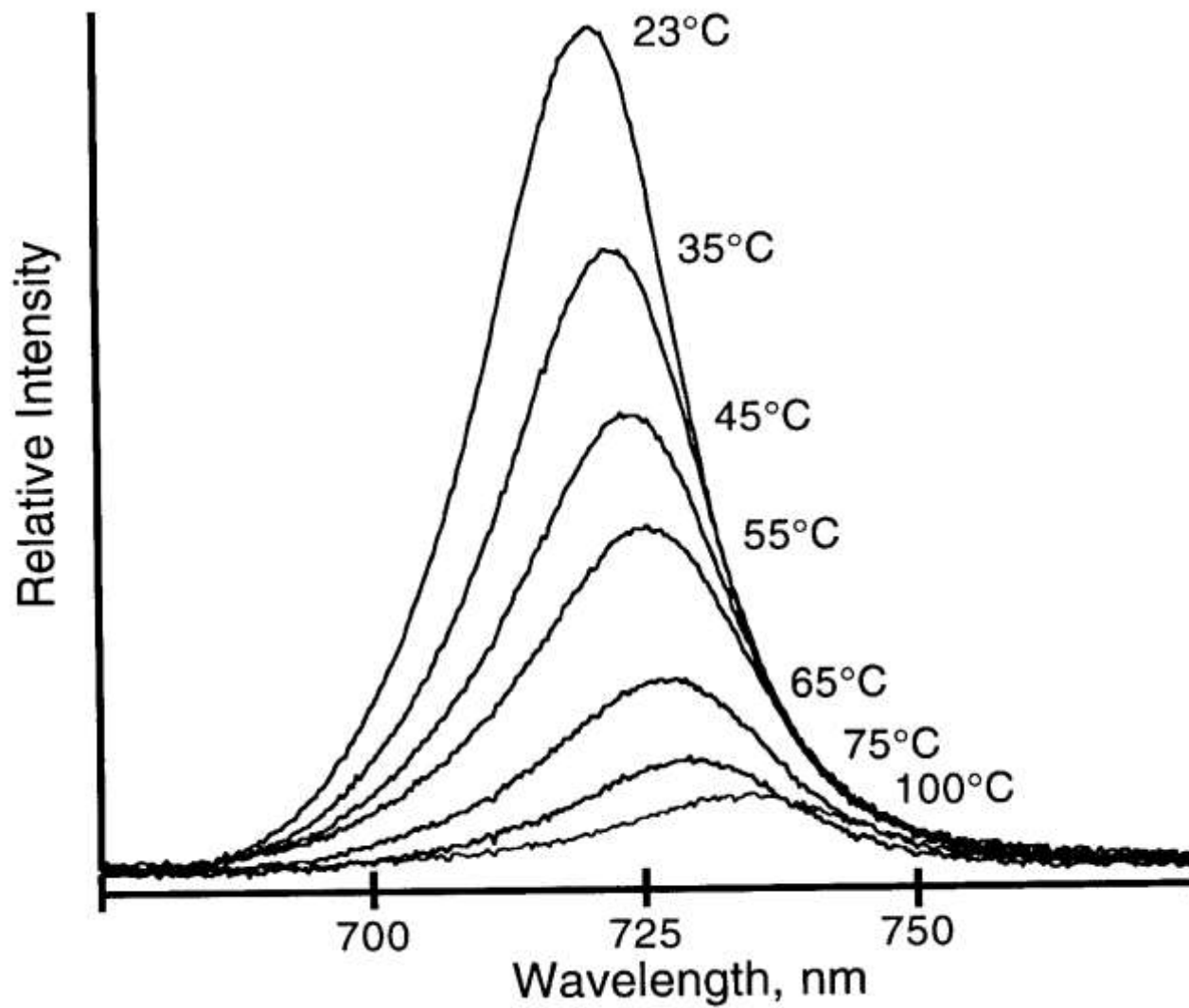

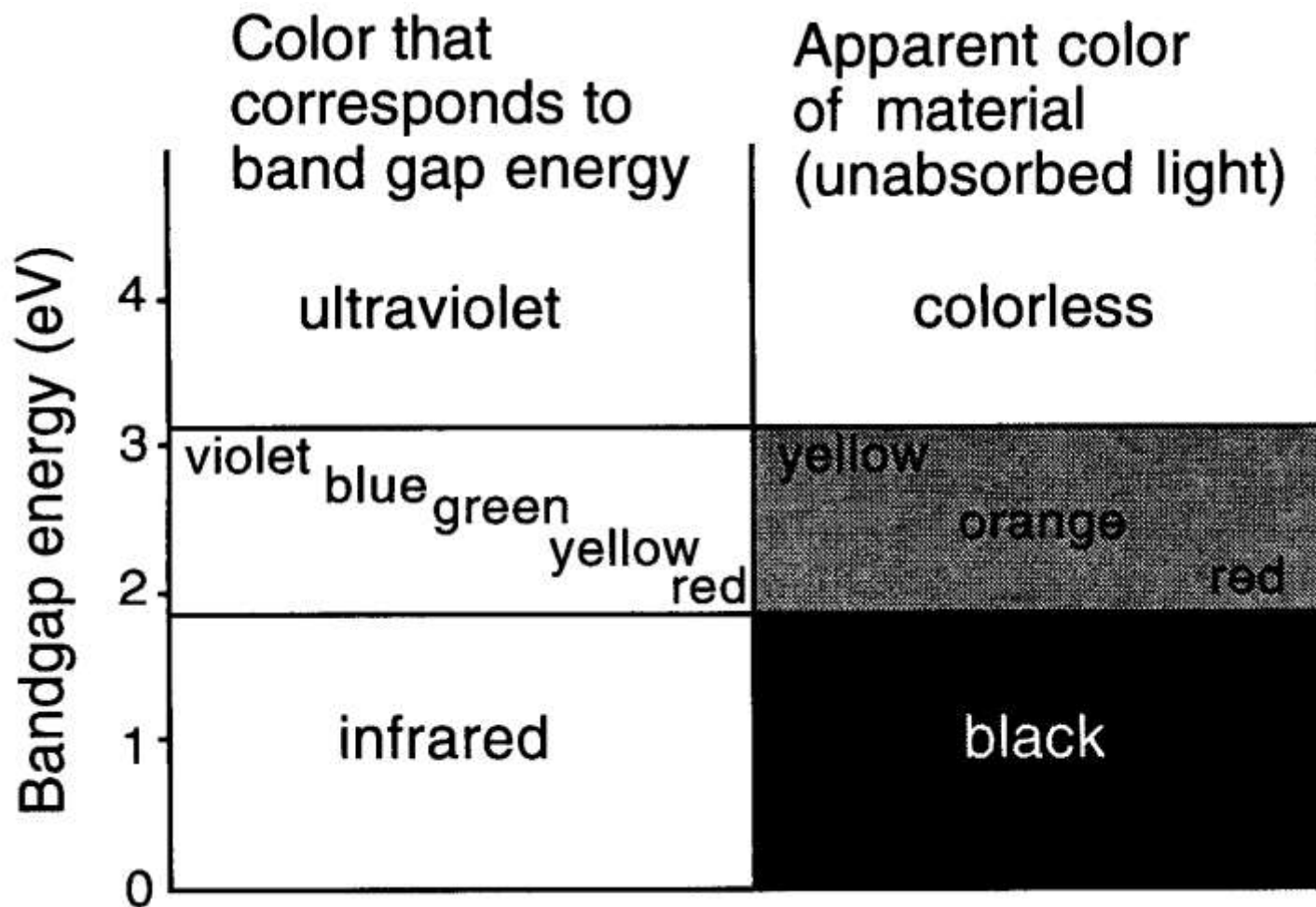

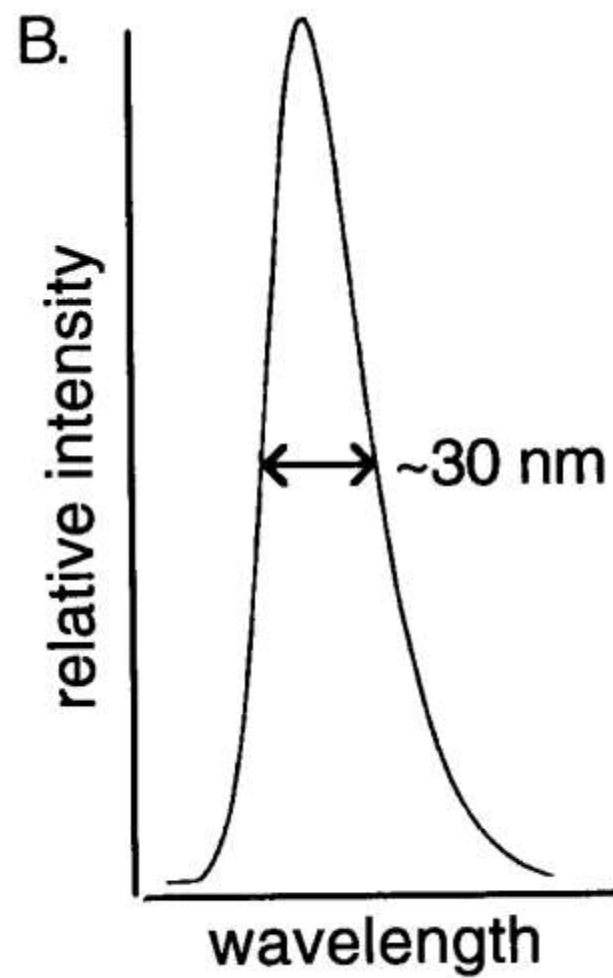
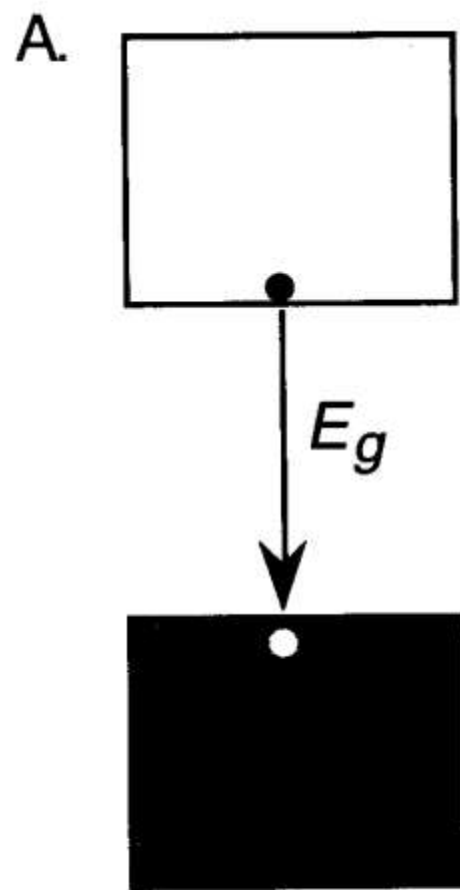

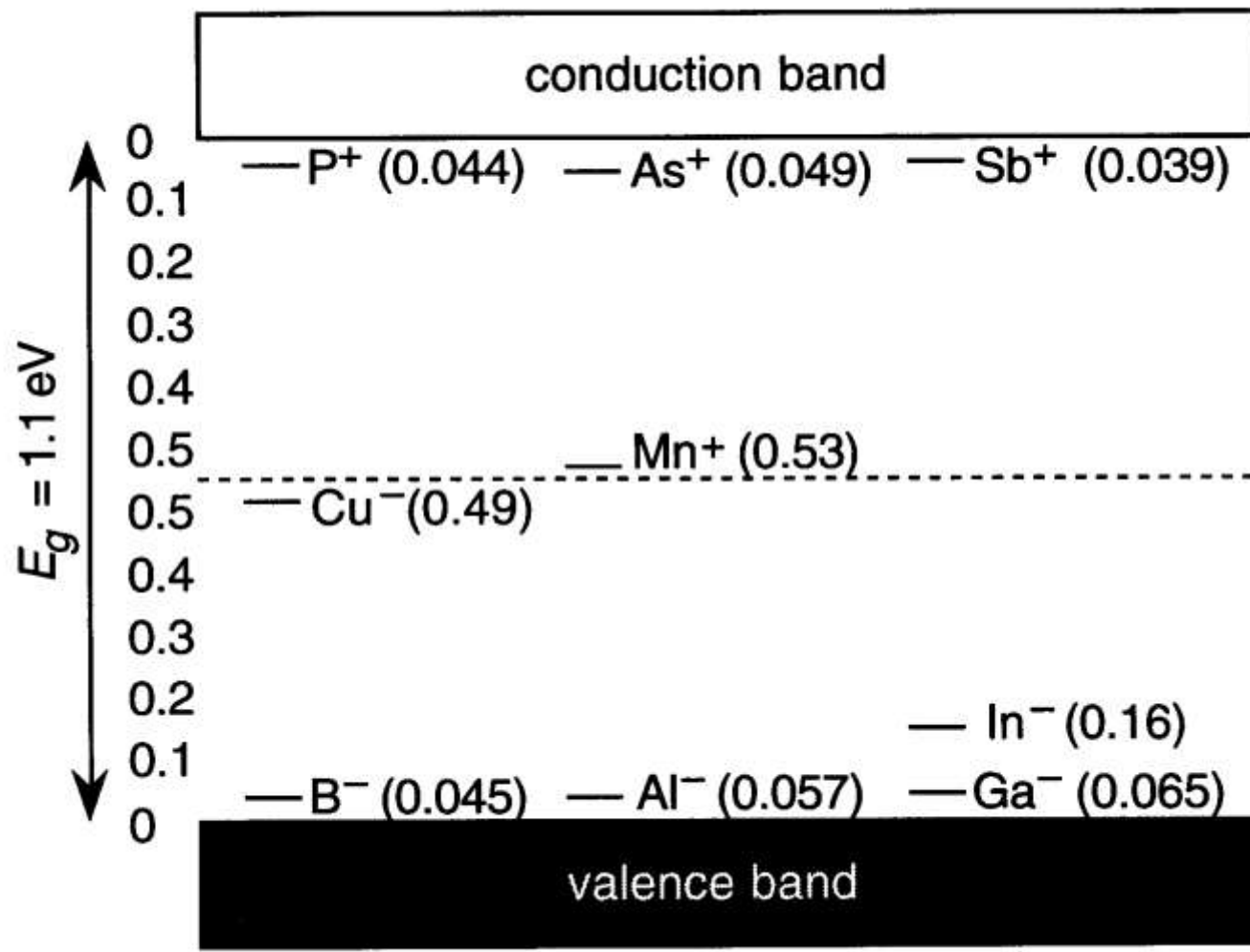

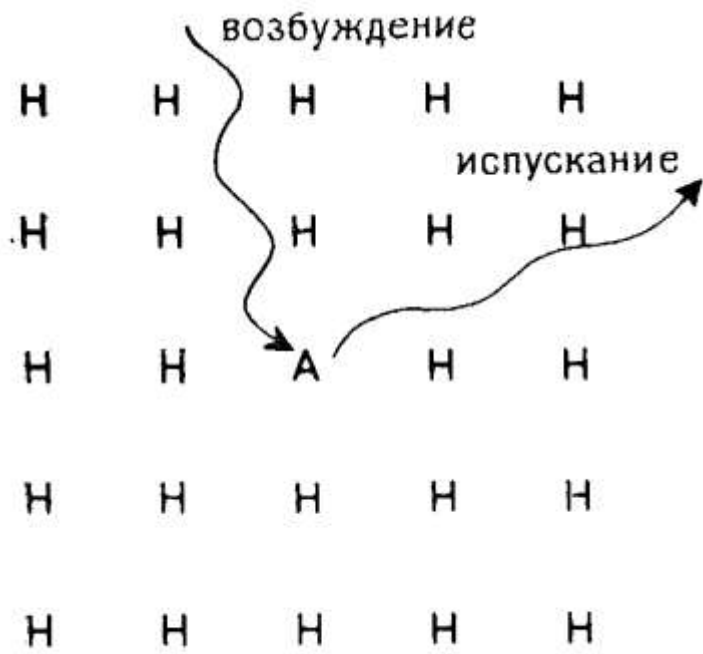

a



б

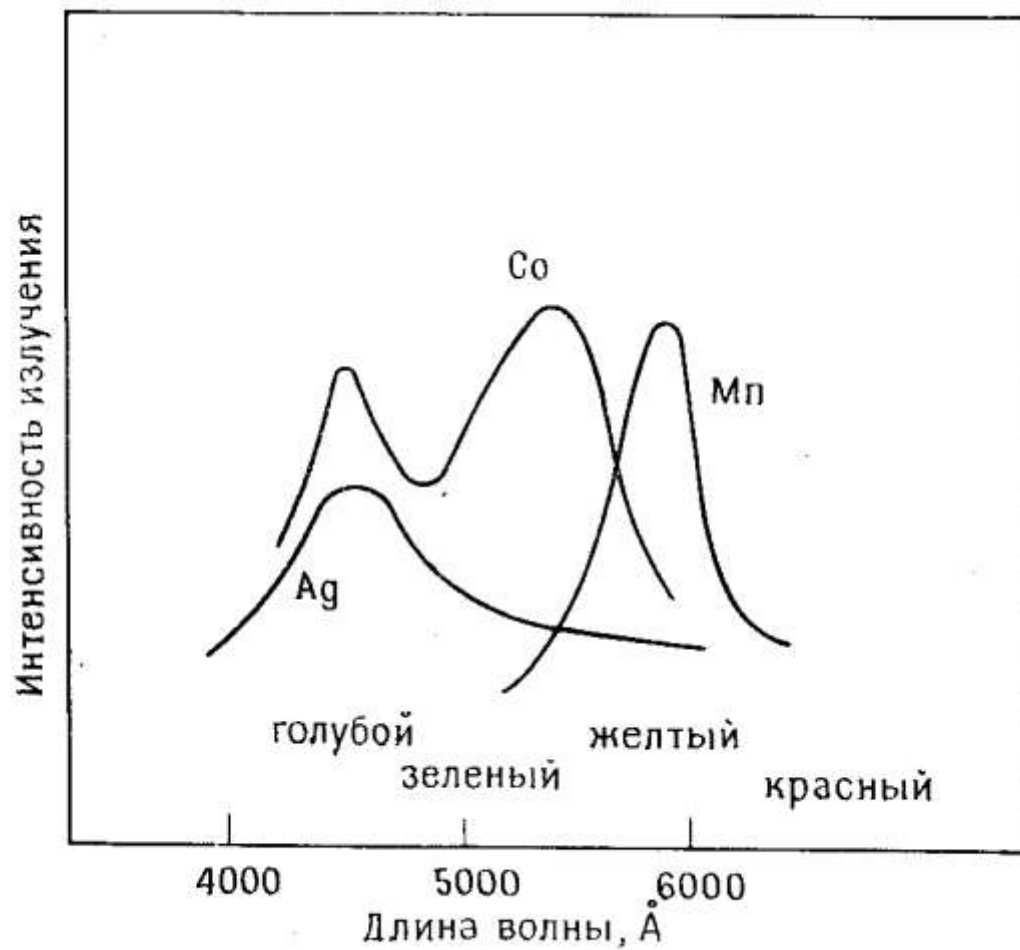

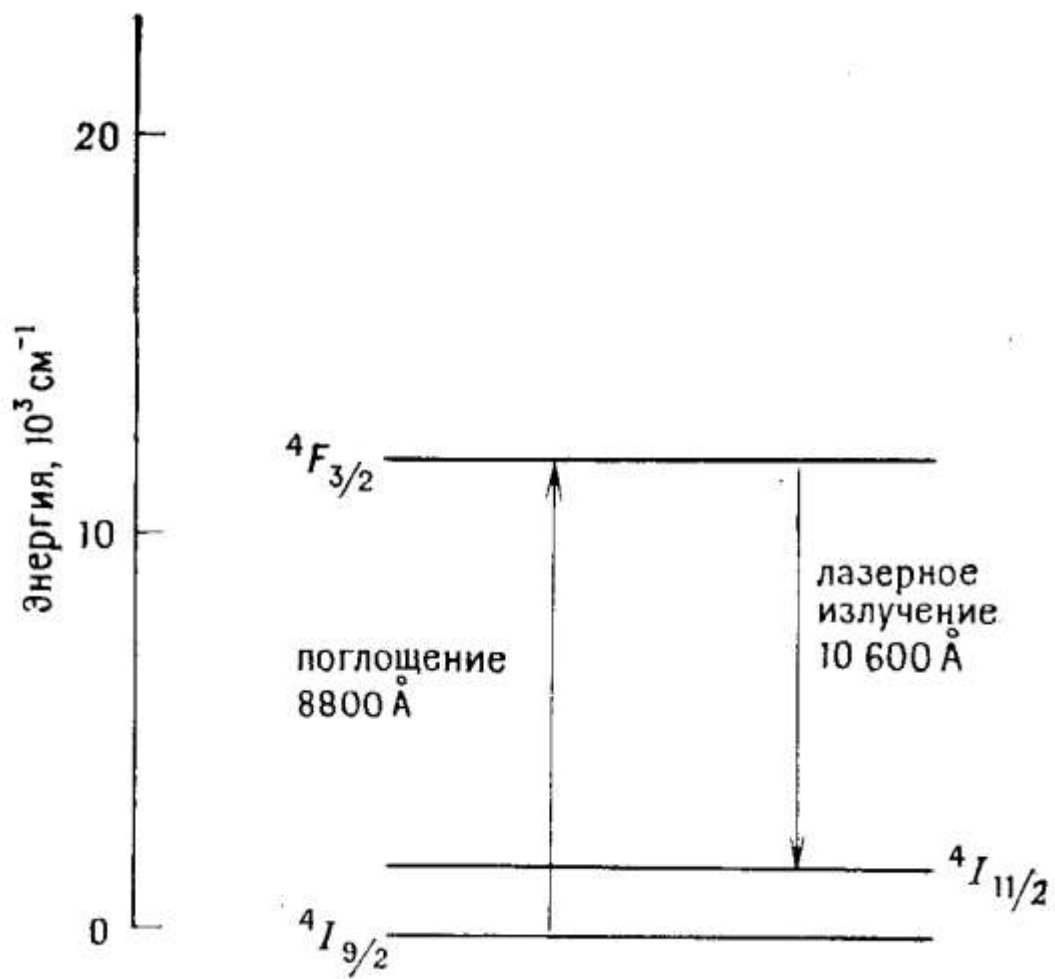

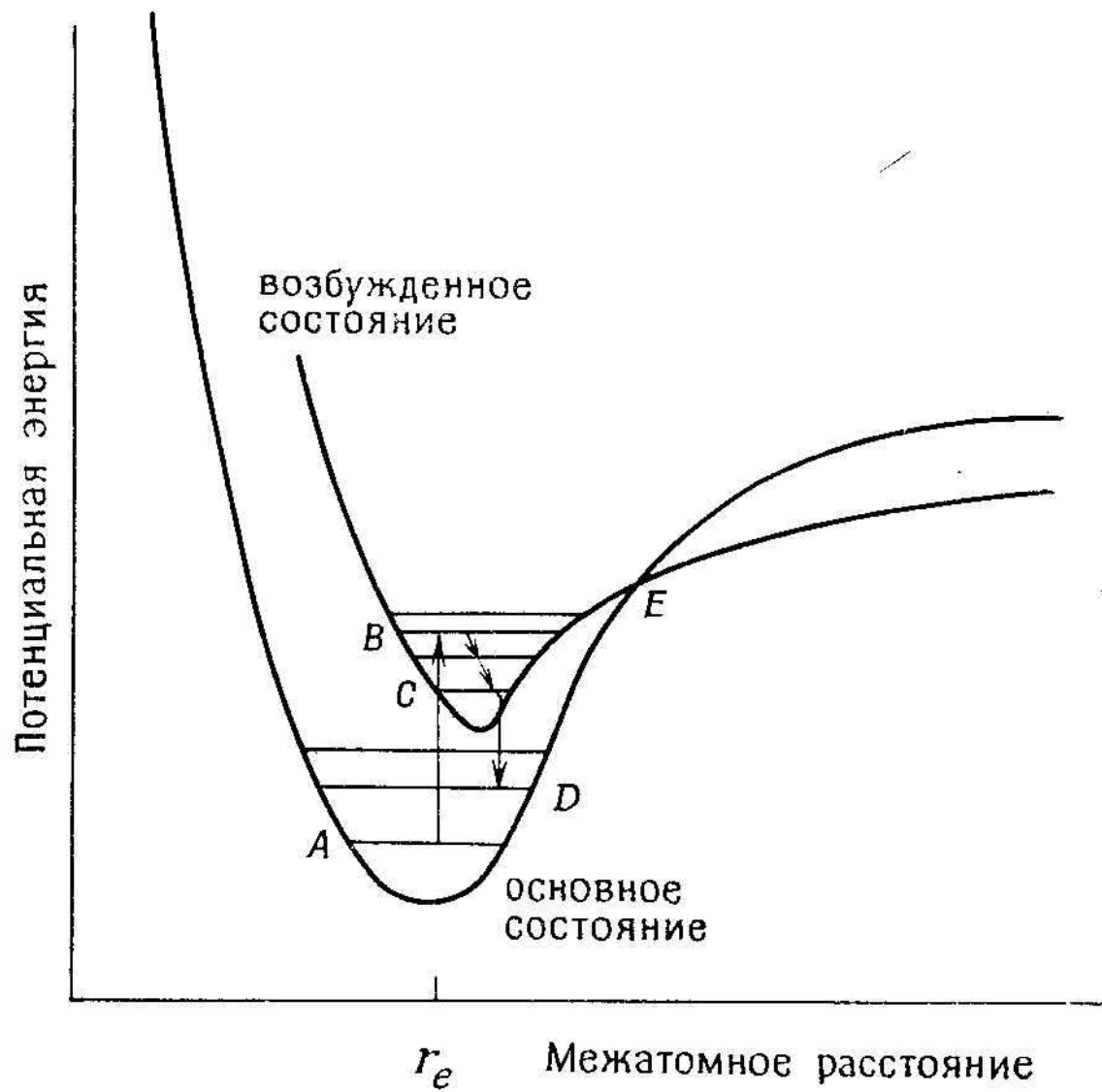

↑
Потенциальная
энергия

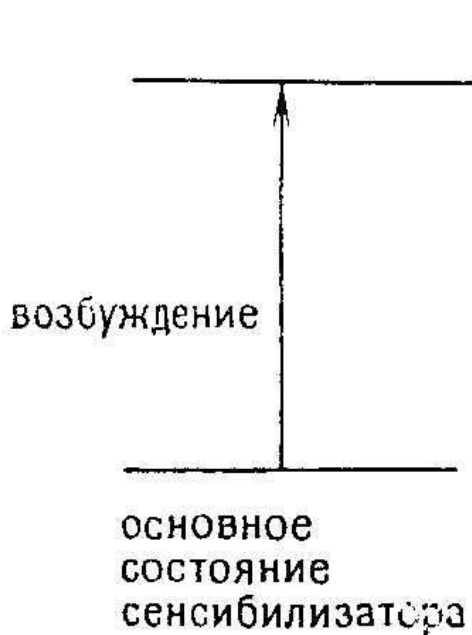

перенос
энергии

